

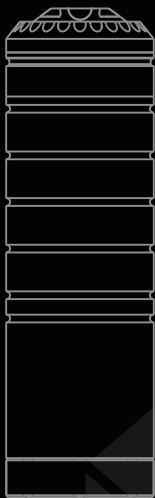

ESHOOTER MASTER

FLARE SMOKY BT
TRACER UNIT

USER MANUAL V1.2.0



Product Overview

Dear customers

Thanks for purchasing our FLARE. In order to help you know how to use it better, please kindly read this manual before using and remember to keep it well.

Package include: 1 x Flare Tracer Unit, 1 x Adaptor(M14-CCW to M11+CW), 1 x Type C Charging Cable, 1 x Allen Wrench, 2 x Rubber ring, 1 x Rubber stopper

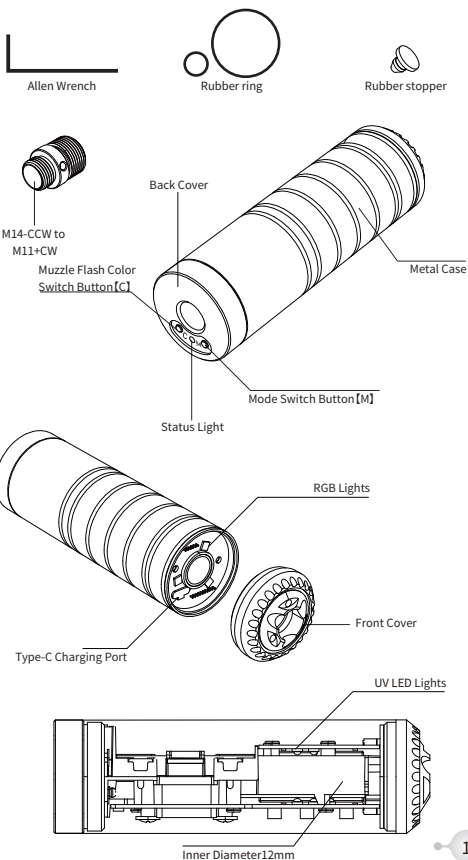

Essential Oil Refill Instructions

1

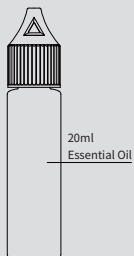

2

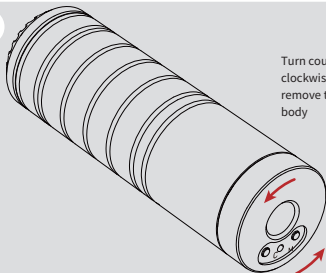

3

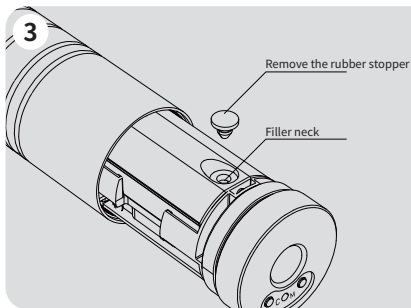

4

Gently press the bottle
Fill with Essential Oil
(Fill up about 4ml)

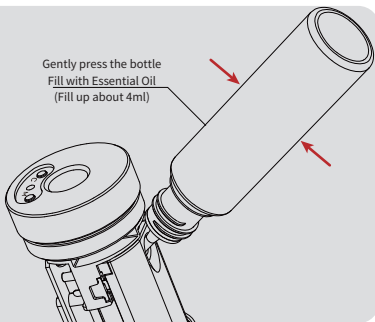

DISCLAIMER ABOUT ESSENTIAL OIL FOR FLARE SMOKY TRACER UNIT

- Only use the officially provided essential oils from ESHOOTER. These exclusive oils have been certified non-toxic and harmless through MSDS testing.
- The oil tank is manufactured from corrosion-resistant PCTG material and is intended solely for use with ESHOOTER's certified essential oils.
- ESHOOTER shall not be held liable for any product damage, personal injury, or legal consequences resulting from the use of e-cigarette oils or any other liquids from unauthorized or unknown sources.
- ESHOOTER reserves the right to take legal action against any illegal or irregular issues caused by improper use of other liquids, defamation or other defamation of our company.

Warning

Flare Smoky Tracer Unit Instructions for use:

1. Filling Tips: 90% full is enough for first use which supports around 10000 shots.
2. Maintenance: The oil may stain on the inner tube of the light emitter after every 2-3k rounds, please clean it to ensure stable performance.
3. Abnormal oil accumulation treatment: If oil accumulates inside the front cover, please check whether the front cover and the back cover are installed in place.
4. Common phenomena in smoke mode: There may be no smoke in the first 1-2 rounds, which is a normal warm-up process. If there is no smoke continuously:
 - A. Check whether the indicator light port and the blower air inlet are blocked.
 - B. Confirm whether the tank has enough oils.
5. Unable to use while charging, please unplug the power and restart.
6. It is forbidden to maliciously use the transmitter to directly irradiate human eyes, and ESHOOTER will not be responsible for the damage caused by this!
7. Please turn off in time when not in use. If the battery is not charged for more than 3 months, the battery may be over-discharged and its lifespan will be reduced or even damaged.
8. It is forbidden to throw it into the fire, because the battery in the light emitter may explode and pollute the environment.

Product Specification

Product Model	V902	Rated Input	5V = 0.5A
Size	126 x 38(φ)mm	Standby Current	<6 μA
Weight	105 g	Working Current	<800mA
Case Material	Metal	Usage time	≤6h
Temperature Range	-20°C ~ 60°C	Standby time	≥3Months
Battery Capacity	740 mAh	User Age	14 +



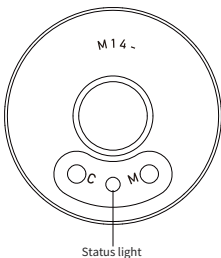











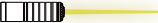

Instructions



Each time you press the mode switching button [M] to switch a function, long press to turn on the smoke function.

Status light	Mode	Status
● Purple light blinks 1 time per second	Muzzle Flash	
● Green light blinks 1 time per second	Tracer with Muzzle Flash	
● Blue light blinks 1 time per second	Tracer	
○ White light blinks 1 time per second	Tracer Ratio	
● Purple light blinks 2 times per second	Muzzle Flash+Smoke	
● Green light blinks 2 times per second	Tracer with Muzzle Flash + Smoke	
● Blue light blinks 2 times per second	Tracer + Smoke	
○ White light blinks 2 times per second	Tracer Ratio + Smoke	
● Red light blinks 2 times	Turn OFF	
● Red light flashing	Battery Low	
● Red light always on	Charging	
● Green light always on	Fully charged	

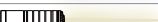
Each time you press the color switching button [C] to switch a new color
9 colors cycle through
Note: Do not look directly at the RGB lamp beads when switching colors

RGB Lights	Function Description	Display State
	Displays current color when mode is switched to Muzzle Flash or Tracer with Muzzle Flash	
		
		
		
		
		
		
		
	Displays 8 colors cycle when mode is switched to Muzzle Flash or Tracer with Muzzle Flash	

Product Notice

Sleep&Active

If the FLARE is not work for 5 minutes, it will automatically go to sleep, and shake the product to activate the device again. (Active shutdown cannot be activated by shaking)

Charging

The Type-C charging port only supports DC 5V power supply ,Please use a regular mobile phone charger or power bank to charge ; When charging, the red light is always on. When fully charged, the green light is always on. It takes about 2 hours to fully charge.

Low battery warning

When the battery is low, the working indicator light will flicker red, which is a low battery alarm reminder, please charge it in time!

Installation notes

Please make sure that the inner barrel of the gun does not exceed the barrel thread by 10mm, otherwise it will not work properly.

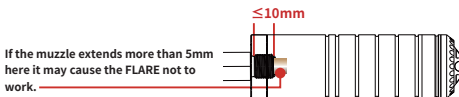

When installing the M11+ internal barrel pistol, you must use the M14- to M11+ adapter, and use the Allen wrench to tighten the adapter.

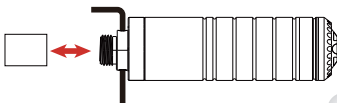

App Instruction

1. Download and install the App

By searching “ESHOOTER” at the App Store or google Play, you also could scan the QR code we provide

2. Connect with your device

Make sure your device is charged and open the App, then click “FLARE SMOKY” and come to its interface, click the device

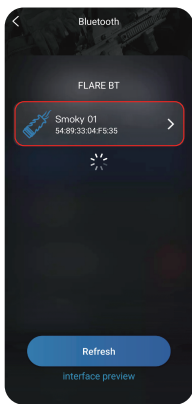
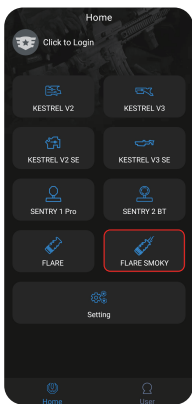

App Interface

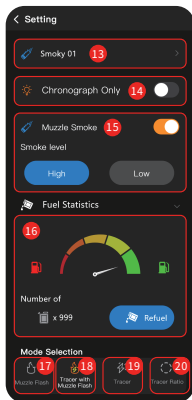
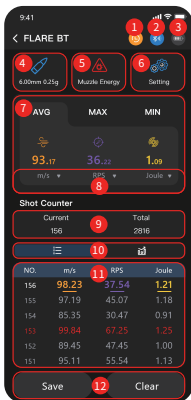

1. History Record

Click  to check history records.

3. Battery Power

Check the battery power here. Please charge it in time when the battery is low.

4. BBs Options

Click  to modify diameter and weight.



2. Bluetooth Connection

Click  to search 'FLARE BT' and connect. If the Bluetooth signal is weak, please close to the unit and connect it.

5. Muzzle Energy

Click  to modify the limited range of kinetic energy.



6. Tracer Setting

7. Muzzle velocity, Rate of fire, Average kinetic energy, maximum and Minimum displayed

8. Muzzle velocity unit switch, ROF unit switch, Energy unit switching

- 9. Shot Counter
- 10. Data Display and Switching
- 11. Real-time Dashboard
- 12. Data saving and clearing function
- 13. Bluetooth name customize
- 14. Chronograph Function (Note: This function will not have tracer and flame effect after turning on.)
- 15. Smoky Level
- 16. Fuel Statistics
- 17. Muzzle Flash
- 18. Tracer with Muzzle Flash
- 19. Tracer
- 20. Tracer Ratio

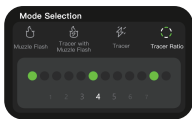

This mode can better adjust the BBs trajectory. After turn on, the BBs will be colored like your interval setting (from 1 to 10).

21. Single Color Mode

Customize the flame color according to your setting.



22. Single Color Mode Recommended

23. Dynamic Color

As above, the dynamic colors order(can be deleted or added) and time interval can be adjusted(from 0.5 to 2s).



24. Muzzle Flash Brightness Adjustment

Slide the progress bar left and right to adjust the brightness of the flame.

25. Sensor Test Mode

Check the lights in working or not. Check that the lights are working properly.

26. Version

27. Reset

Click to reset all settings.

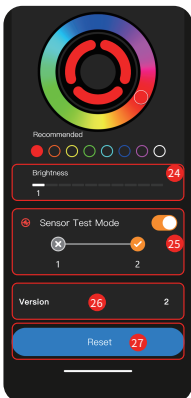

Declaration of Toxic and Hazardous Substances

Parts	Toxic and Hazardous Substances or Elements					
	Plumbum (Pb)	Mercury (Hg)	Cadmium (Cd)	Chromium VI (Cr6+)	Poly-brominated biphenyls (PBB)	Poly-brominated diphenyl ethers (PBDE)
Plastic	○	○	○	○	○	○
Metal	✕	○	○	○	○	○
PCB	✕	○	○	○	○	○
Other	✕	○	○	○	○	○

○ Indicates that the content of the toxic and harmful substances in all homogeneous materials of the part is less than the requirement in SJ/T-11363-2006 《Limit requirements for toxic and harmful substances in electronic products》.

✕ Indicates that the content of the toxic or hazardous substance is at least in one homogeneous material of the part exceeds the limit requirement by SJ/T11363-2006. This product complies with RoHS environmental protection requirements: At present, there is no mature technology in the world that can replace or reduce the lead content in electronic ceramics and copper alloys.



FCC WARNING

This device complies with part 15 of the FCC Rules. Operation is subject to the following two conditions:

- (1) this device may not cause harmful interference, and
- (2) this device must accept any interference received, including interference that may cause undesired operation.

Any changes or modifications not expressly approved by the party responsible for compliance could void the user's authority to operate the equipment.

NOTE: This equipment has been tested and found to comply with the limits for a Class B digital device, pursuant to Part 15 of the FCC Rules. These limits are designed to provide reasonable protection against harmful interference in a residential installation. This equipment generates, uses and can radiate radio frequency energy and, if not installed and used in accordance with the instructions, may cause harmful interference to radio communications.

However, there is no guarantee that interference will not occur in a particular installation. Which can be determined by turning the equipment off and on, the user is encouraged to try to correct the interference by one or more of the following measures:

- Reorient or relocate the receiving antenna.
- Increase the separation between the equipment and receiver.
- Connect the equipment into an outlet on a circuit different from that to which the receiver is connected.
- Consult the dealer or an experienced radio/TV technician for help.

The device has been evaluated to meet general RF exposure requirement. The device can be used in portable exposure condition without restriction.

After Sale Policy

Please keep this warranty card, purchase receipt and product packaging properly. Please present them when after sales service is requested.

1. FLARE has 6 months warranty service since the date of purchase.
2. If there is any quality issued under the normal operation (not man-made damaged) while the product has not been disassembled by unauthorised technicians, the product is free for replacement in the first 30 days from the date of purchase.
3. During the warranty period, if there is a quality defected be found in the normal operation, free repair service is provided after the production is inspected and verified by the authorised technicians. Warranty service does not include the transportation cost and door to door service.
4. Warranty is void under the below circumstances, free repair service is no longer provided if:
 - 4.1 User does not follow the instruction menu, mis-installation, storage and use which lead to the product failure or damage.
 - 4.2 Any damage caused by force majeure reasons.
 - 4.3 Product failure or damage caused by the disassemble or modification by the unauthorised technicians.
 - 4.4 Warranty card or purchase receipt is not provided.
 - 4.5 Warranty period is expired.
5. Warranty service would be refused to provide if there original warranty card is not presented, the repair record is not consistent with the fact, any alteration or unrecognised description on the warranty card.

Warranty Card

Name : _____

Phone Number : _____

Email : _____

Address : _____

Item Model : **FLARE SMOKY BT** _____

Inspector : _____

Date of Production : _____



ESHOOTER MASTER

FLARE SMOKY BT TRACER UNIT



ESHOOTER App



www.eshooter-world.com





Watch the Video

E-SHOOTER TECHNOLOGY (SHENZHEN) CO.,LTD.

 No.1 Yabao Road, Longgang District, Shenzhen, China

 0086 0755 84503091

 support@eshooter-world.com

 www.eshooter-world.com



EShooter_Tech



Eshooter_Tech



Eshooter_Tech



E - shooter